

Your success counts

Flow rate Indicator / Totalizer with analog and pulse signal outputs



The F-Series is your first and safest choice for field mount indicators in safe and hazardous area applications. Especially in harsh weather conditions like rain, snow, salty atmospheres and temperatures between -40°C up to $+80^{\circ}\text{C}$ (-40°F up to 176°F).

Advantages

- Robust aluminum or stainless steel 316L field enclosure (IP67 / NEMA Type4X). It is so rugged, a truck can even stand on it!
- Intrinsically Safe available - ATEX and IECEx approval for gas and dust applications.
- Programming can be done by your own crew, with the sensible menu-driven structure, saving cost and irritation. Know one, know them all!
- Very diverse mounting possibilities: walls, pipes, panels or directly onto outdoor sensors!

Features

- Displays instantaneous flow rate, total and accumulated total.
- Large 17mm (0.67") digit selection for flow rate or total.
- Easy configuration with clear alphanumeric display and descriptions.
- LED backlight option.
- Selectable on-screen engineering units; volumetric or mass.
- Ability to process all types of signals: Sine wave (coil), NAMUR, NPN/PNP pulse, Reed-switch, Active pulse signals, (O)4-20mA.
- Pulse output according to accumulated total.
- Analog (loop powered) output according to flow rate.
- Full Modbus communication RS232/485/TTL.
- Power requirements: Loop or battery powered, 8 - 30V DC, 8 - 24V AC/DC or 115 - 230V AC.
- Sensor supply: 3 / 8.2 / 12 / 24V DC.
- Auto backup of settings and running totals.

Introduction

The F110 is the most popular model in our range of flow rate / totalizers, complete with pulse and analog output signals. Even demanding applications are catered with our base unit configuration. A wide selection of options further enhances the capabilities of this model, including Intrinsic Safety and full Modbus communication.

Display

The display has large 17mm (0.67") and 8mm (0.31") digits which can be set to show flow rate and totals. On-screen engineering units are easily configured from a comprehensive menu. The accumulated total can register up to 11 digits and is backed-up in EEPROM memory every minute. For those applications where readability during day and night is an issue, a white backlight is available.

Configuration

All configuration settings are accessed via a simple operator menu which can be password protected. Each setting is clearly indicated with an alphanumerical description, which avoids confusing abbreviations and baffling codes. Once familiar with one F-series product, you will be able to program all models in the series without a manual. All settings are safely stored in EEPROM memory in the event of sudden power failure.

Communication

All process data and settings can be read and modified manually or through the Modbus communication link (RS232 / RS485). Full Modbus functionality remains available for the Intrinsically Safe version (TTL).



Pulse output

The scaleable pulse output, reflects the count on the accumulated display. The pulse width is user defined from 0.001 second up to 9.999 seconds. The maximum output frequency is 500Hz. The output signal can be passive NPN, active PNP or an isolated electro-mechanical relay.

Hazardous areas

This model is ATEX and IECEx certified as Intrinsically Safe for gas and dust applications, with an allowed ambient temperature of -40°C to +70°C (-40°F to +158°F).

Analog output signal

The flow rate is re-transmitted with the (0)4-20mA or 0 - 10V DC output signal. The output signal is updated eight times per second with a filter function being available to smoothen out the signal if desired. The output value is user defined in relation to the flow rate, e.g. 4mA equals to 15L/Hr and 20mA equals to 2000L/Hr. The output signal can be passive, active or isolated where the passive output type will loop power the F110 as well.



All info at a glance



Easy to install



Easy to program



Know one know them all!



Reliable



User-friendly

Overview application F110

The F-Series is your first and safest choice for field mount indicators in safe and hazardous area applications. Especially in harsh weather conditions like rain, snow, salty atmospheres and temperatures between -40°C up to +80°C (-40°F up to 176°F). Liquid flow measurement where re-transmission of the flow rate and/or totalizer functions or serial communication is required. Alternative basic models: F010 - F011 - F012 - F014 or more advanced F112 - F113 - F118 or the E-Series explosion proof flow rate indicators.

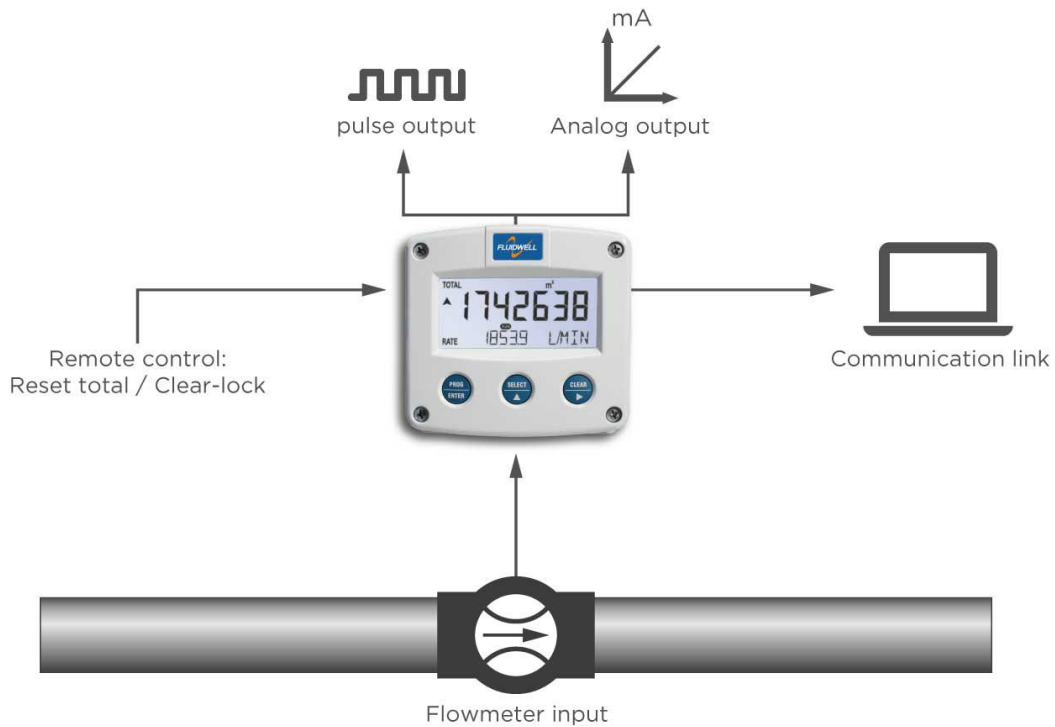

Signal input

The F110 accepts most pulse and analog input signals for volumetric flow or mass flow measurement. The input signal type can be selected by the user in the configuration menu without having to adjust any sensitive mechanical dip-switches or jumpers. The analog input is available with linear and square root calculation and even as 4 - 20mA input loop powered.

Type of signal	Resistance	Low Pass filter (LP)	Max. frequency	Max. frequency Low Pass filter (LP)	Min. amplitude p-p	Remark
NPN	100kΩ pull-up	100kΩ pull-up	6kHz Threshold 1.2V	1.2kHz		Open collector
REED	1MΩ pull-up	1MΩ pull-up	1.2kHz Threshold 1.2V	120Hz		
PNP	100KΩ pull-down	100KΩ pull-down	6kHz Threshold 1.2V	1.2kHz		
NAMUR	820Ω pull-down	-	4kHz	-		External power required
COIL LO	-	-			80mV _{pp}	Default sensitivity
COIL-HI					20mV _{pp}	Sensitive for interference!
COIL-HI (Type ZF)					10mV _{pp}	
ACTIVE 8.2V DC	3K9Ω		10kHz Threshold 4V			External power required
ACTIVE 12V DC	4KΩ		10kHz Threshold 6V			External power required
ACTIVE 24V DC	3KΩ		10kHz Threshold 12V			External power required

Enclosures

Various types of enclosures can be selected, all ATEX and IECEx approved. The F110 is supplied in an GRP panel mount enclosure as standard, which can be converted to an IP67 / NEMA Type4X GRP field mount enclosure by the addition of a back case. Most popular is our robust aluminum field mount enclosure which is also available with an extended backcover with undrilled preparation for direct meter mounting at the back side. It is so rugged, even a truck can stand on it! For the most challenging environments we have a durable high grade Stainless steel 316L enclosure. All enclosures have a IP67 / NEMA Type4X rating and EU or U.S. cable gland entry threads available.

Dimensions enclosures

Aluminum & GRP panel mount enclosure

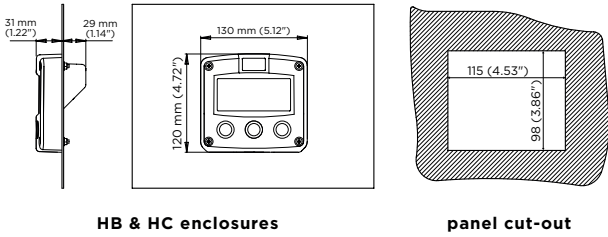

Aluminum, GRP & Stainless steel 316L field mount enclosures

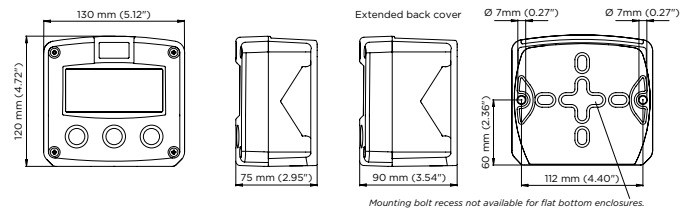

Cable entries

Aluminum / Stainless Steel

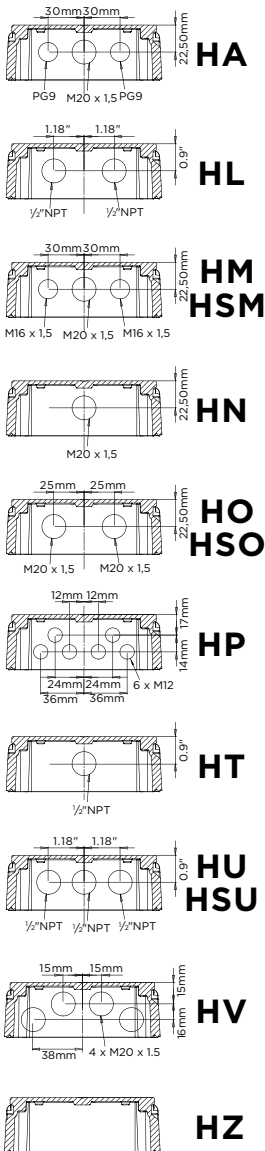

GRP

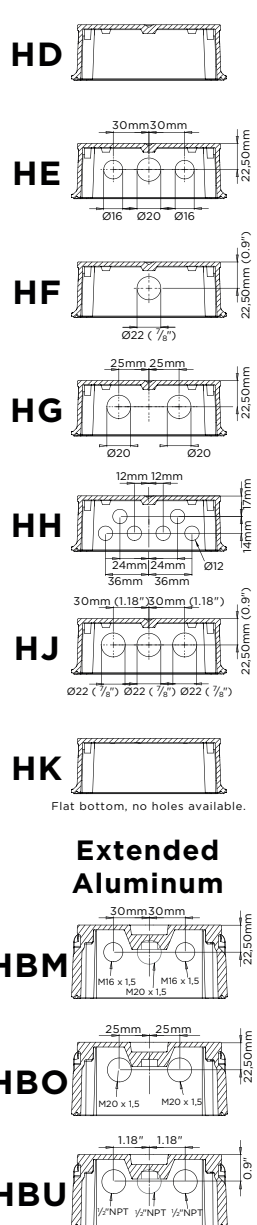

Terminal connections

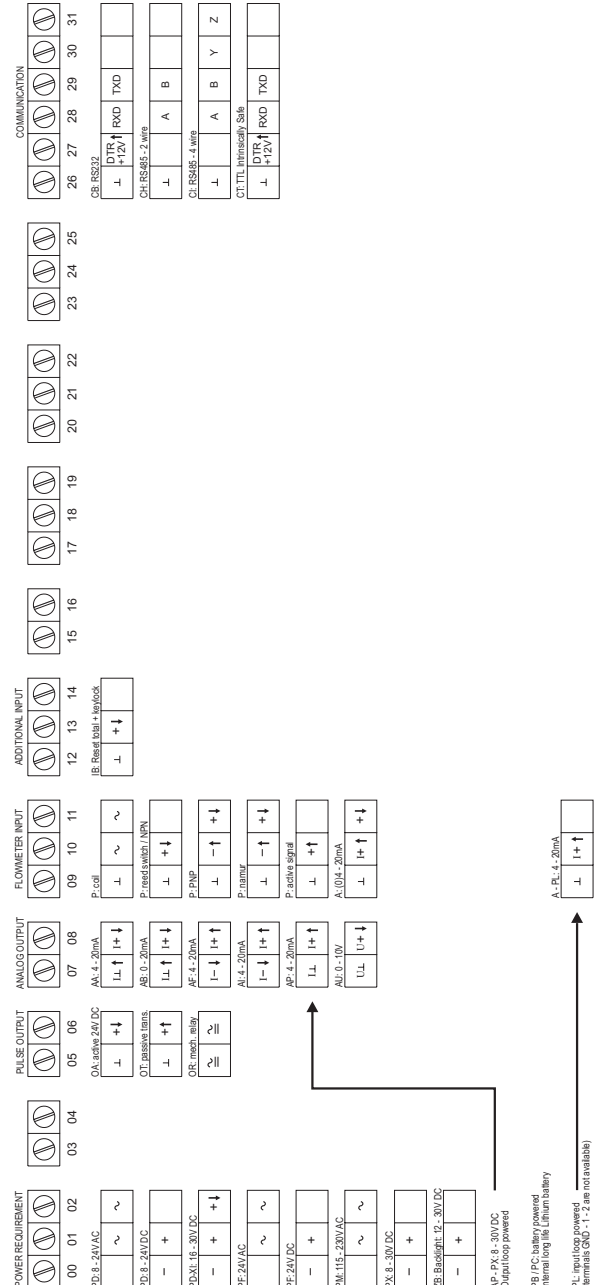

Configuration example F110-P-AP-CH-IB-OT-(PX)-XX-ZX

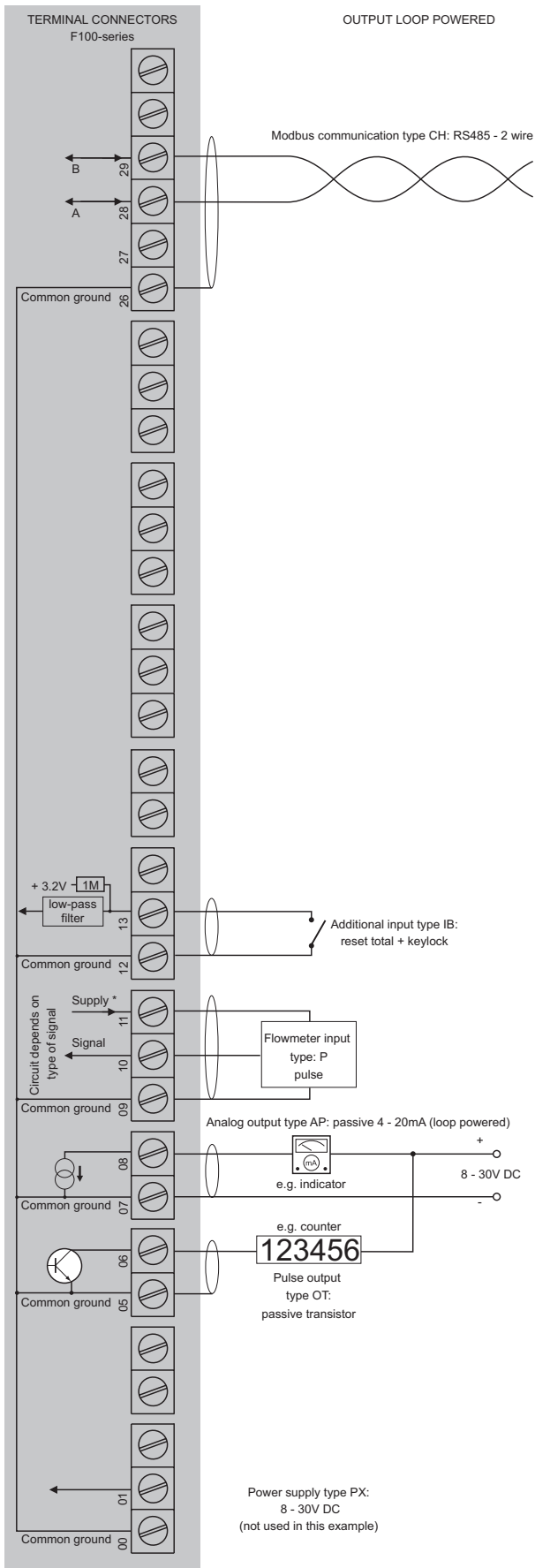

* For pulse type inputs: V_{ref} : 1.2V/3.0V available.- NO power output, available I_{supply} : <1mA. Note: using these ref. voltages at max. load, will reduce battery life significantly.

Configuration example F110-A-AI-CI-IB-OR-PM-XX-ZX

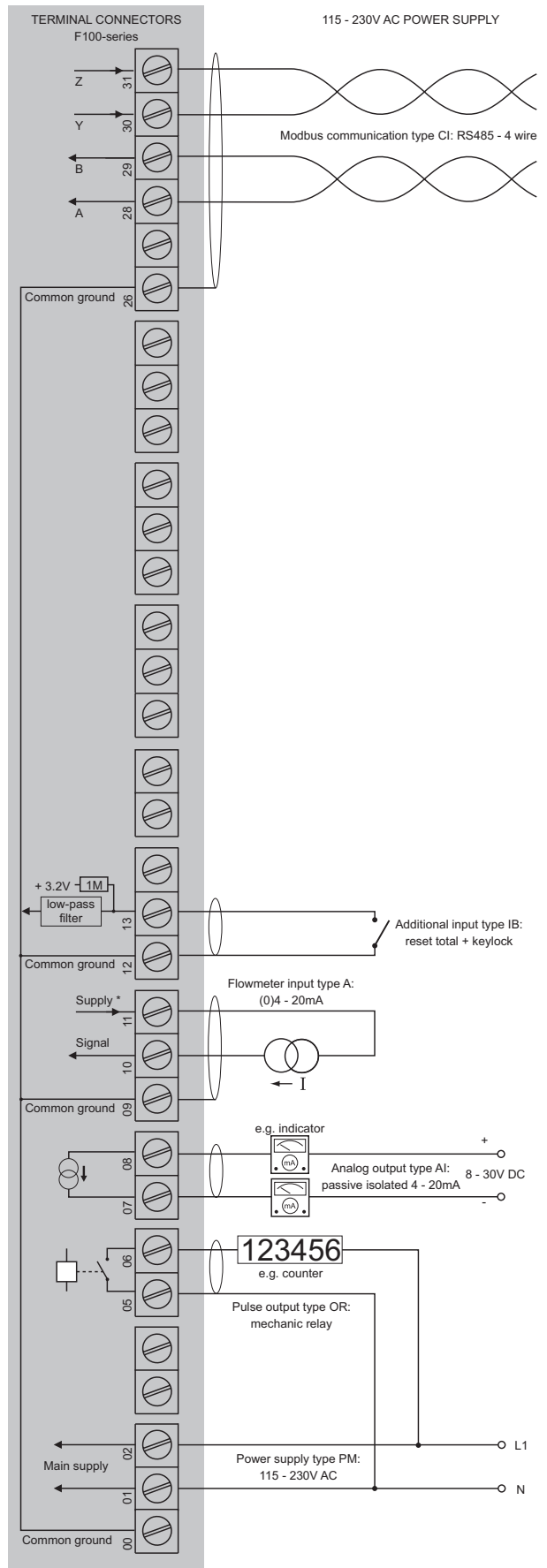

* Supply voltage: 3 / 8.2 / 12 / 24V DC to sensor

Hazardous area applications

The F110-XI has been certified according to ATEX and IECEx by DEKRA for use in Intrinsically Safe applications with an ambient temperature of -40°C to +70°C (-40°F to +158°F).

- The ATEX markings for gas and dust applications are:

Gas: **II 1 G Ex ia IIB/IIC T4 Ga**

Dust: **II 1 D Ex ia IIIC T100 °C Da.**

- The IECEx markings for gas and dust applications are:

Gas: **Ex ia IIC/IIB T4 Ga**

Dust: **Ex ia IIIC T100 °C Da.**

Besides the I.S. power supply for the pulse output, it is allowed to connect up to three I.S. power supplies in IIB/IIIC applications or one in IIC applications. Consult the certificate for the maximum input and output values of the circuits. Full functionality of the F110 remains available, including 4 - 20mA output, pulse output and Modbus communication (type CT). Power supply type PD-XI offers a 8.2V sensor supply e.g. for one Namur sensor. An ATEX approved flame proof Ex d enclosure is available as well. Please contact your supplier for further details.

Certificate of conformity **KEMA 03ATEX1074 X**

- IECEx DEK 11.0042X



Configuration example IIB /IIIC and IIC

F110-P-(AP)-(CT)-IB-(OT)-PC-XI - Battery powered unit

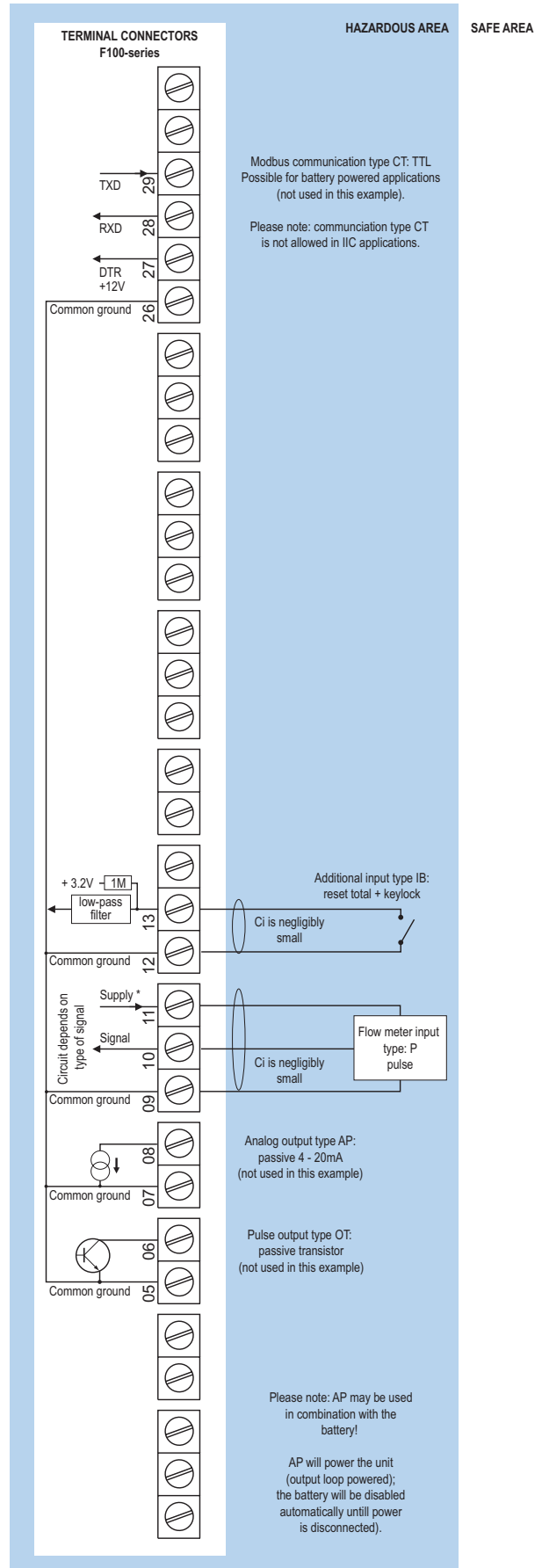

* For pulse type inputs: $V_{ref} = 1.2V/3.0V$ available. - NO power output, available $I_{supply} < 1mA$. Note: using these ref. voltages at max. load, will reduce battery life significantly.

Configuration example IIB /IIC and IIC - F110-P-AP-(CT)-IB-OT-(PX)-XI - Output loop powered

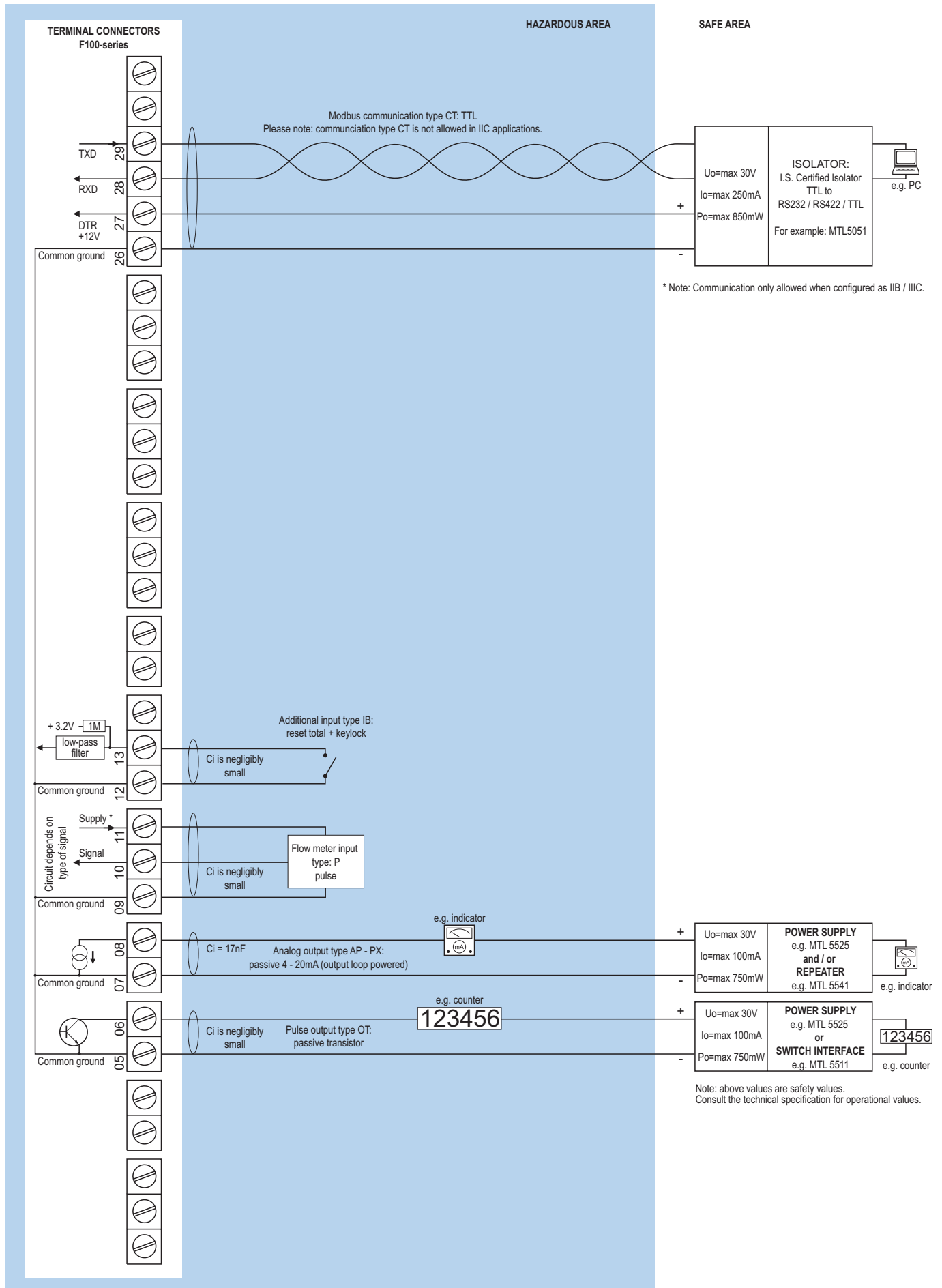

* For pulse type inputs: V_{ref} : 1.2V/3.0V available.- NO power output, available I_{supply} : <1mA.
Note: using these ref. voltages at max. load, will reduce battery life significantly

Configuration example IIB / IIIC and IIC - F110-A-AF-(CT)-IB-OT-PD-XI - Power requirement 16 - 30V DC

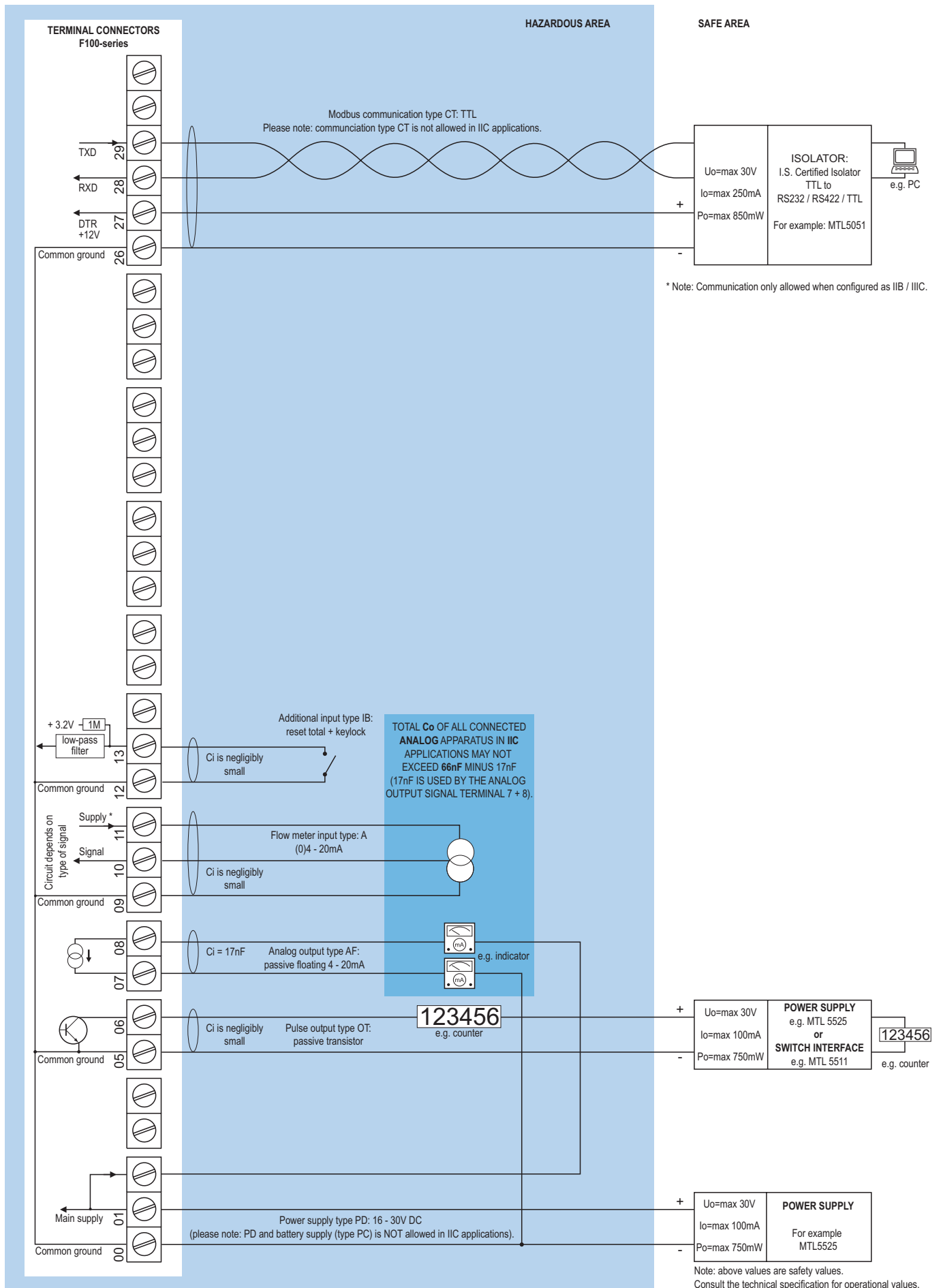

* Note power supply type PD: the supply voltage to pulse sensors is maximum 8.7V (Uo=max 8.7V Io=max 25mA Po=max 150mW) and to analog sensors as connected to terminal 1 (internally linked).

Configuration example IIB / IIIC - F110-A-AF-CT-IB-OT-(PC)-(PD)-XI - Power requirement 16 - 30V DC or battery powered

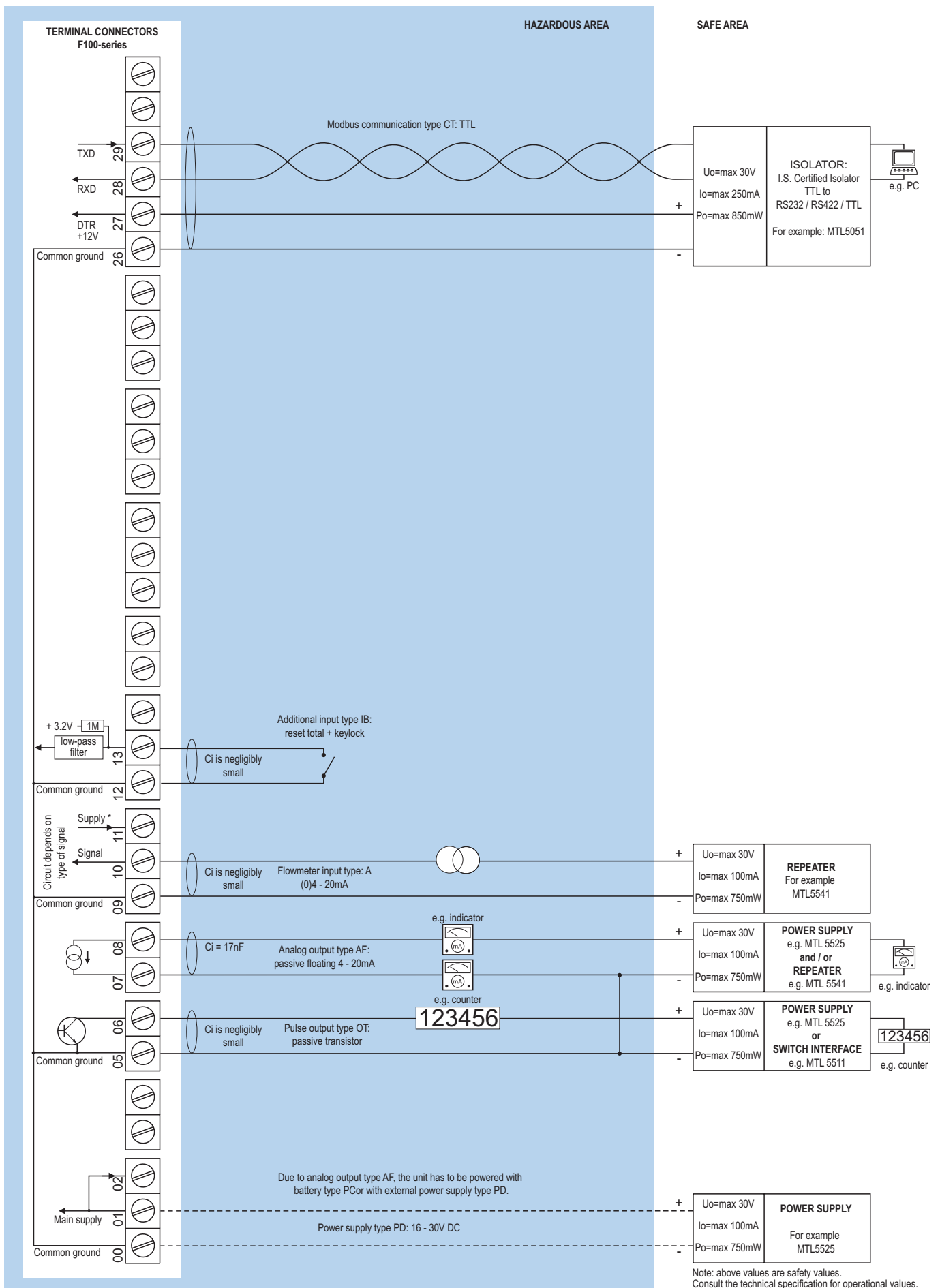

* Note power supply type PD: the supply voltage to pulse sensors is maximum 8.7V (Uo=max 8.7V Io=max 25mA Po=max 150mW) and to analog sensors as connected to terminal 1 (internally linked).

Display

Type	High intensity reflective numeric and alphanumeric LCD, UV-resistant.
Dimensions	90 x 40mm (3.5" x 1.6").
Digits	Seven 17mm (0.67") and eleven 8mm (0.31") digits. Various symbols and measuring units.
Refresh rate	User definable: fast, 1sec, 3sec, 15sec, 30sec, off.
Option ZB	Transflective LCD with white LED-backlight. Intensity can be adjusted in the configuration menu. Good readings in full sunlight and darkness.
Note ZB	Only available for safe area applications.

Ambient temperature

Safe areas	-40°C to +80°C (-40°F to +176°F).
Intrinsically Safe	-40°C to +70°C (-40°F to +158°F).

Terminal connections

Type	Removable plug-in terminal strip. Wire max. 1.5mm ² and 2.5mm ² .
-------------	---

Data protection

Type	EEPROM backup of all settings. Backup of running totals every minute. Data retention at least 10 years.
Password	Configuration settings can be password protected.

Directives & Standards

EMC	Directive 2014/30/EU, FCC 47 CFR part 15.
Low voltage	Directive 2014/35/EU
RoHS	Directive 2011/65/EU
ATEX / IECEx	Directive 2014/34/EU, IEC 600079-0, IEC 60079-11. IP & NEMA EN 60529 & NEMA 250

Intrinsically Safe (Type XI)

ATEX	Gas: II 1 G Ex ia IIB/IIC T4 Ga. Dust: II 1 D Ex ia IIIC T100 °C Da.
IECEx	Gas: Ex ia IIC/IIB T4 Ga. Dust: Ex ia IIIC T100 °C Da.
Ambient Ta	-40°C to +70°C (-40°F to +158°F).

Enclosure

Window	Polycarbonate window.
Sealing	Silicone.
Control keys	Three industrial micro-switch keys. UV-resistant silicone keypad.

Panel mount enclosures

Dimensions	130 x 120 x 60mm (5.12" x 4.72" x 2.36") - W x H x D.
Panel cut-out	115 x 98mm (4.53" x 3.86") L x H.
Type HB	Die-cast aluminum panel mount enclosure IP65 / NEMA Type4X.
Weight	600 gr.
Type HC	GRP panel mount enclosure IP65 / NEMA Type4X, UV-resistant and flame retardant.
Weight	450 gr.

GRP wall / field mount enclosures

General	GRP wall/field mount enclosure IP67 / NEMA Type4X, UV-resistant and flame retardant.
Dimensions	130 x 120 x 75mm (5.12" x 4.72" x 2.95") - W x H x D.
Weight	600 gr.
Type HD	Cable entry: no holes.
Type HE	Cable entry: 2 x Ø 16mm and 1 x Ø 20mm.
Type HF	Cable entry: 1 x Ø 22mm (7/8").
Type HG	Cable entry: 2 x Ø 20mm.
Type HH	Cable entry: 6 x Ø 12mm.
Type HJ	Cable entry: 3 x Ø 22mm (7/8").
Type HK	Flat bottom, cable entry: no holes.

Aluminum wall / field mount enclosures

General	Die-cast aluminum wall/field mount enclosure IP67 / NEMA Type4X with 2-component UV-resistant coating. Extended back cover available with undrilled preparation for direct meter mounting.
Dimensions	130 x 120 x 75mm (5.12" x 4.72" x 2.95") - W x H x D. 130 x 120 x 90mm (5.12" x 4.72" x 3.54") - W x H x D.
Weight	1100 gr. / extended enclosure: 1310 gr.
Type HA	Cable entry: 2 x PG9 and 1 x M20.
Type HL	Cable entry: 2 x 1/2" NPT.
Type HM/HBM	Cable entry: 2 x M16 and 1 x M20.
Type HN	Cable entry: 1 x M20.
Type HO/HBO	Cable entry: 2 x M20.
Type HP	Cable entry: 6 x M12.
Type HT	Cable entry: 1 x 1/2" NPT.
Type HB/HBU	Cable entry: 3 x 1/2" NPT.
Type HV	Cable entry: 4 x M20.
Type HZ	Cable entry: no holes.

Stainless steel 316L wall / field mount enclosures

General	Die-cast stainless steel 316L wall / field mount enclosure with flat bottom. IP67 / NEMA Type4X.
Dimensions	130 x 120 x 75mm (5.12" x 4.72" x 2.95") - W x H x D.
Weight	2700 gr.
Type HSM	Cable entry: 2 x M16 + 1 x M20.
Type HSO	Cable entry: 2 x M20.
Type HSU	Cable entry: 3 x 1/2" NPT.

Signal inputs - Flowmeter

Type P	Coil / sine wave (HI: 20mVpp or LO: 80mVpp - sensitivity selectable), NPN/PNP, open collector, reed switch, Namur, active pulse signals 8 - 12 and 24V DC.
Frequency	Minimum 0Hz - maximum 6kHz for total and flow rate. Maximum frequency depends on signal type and internal low-pass filter. E.g. reed switch with low-pass filter: max. frequency 120Hz.
K-Factor	0.000010 - 9,999,999 with variable decimal position.
Low-pass filter	Available for all pulse signals.
Option ZF	coil sensitivity 10mVpp.
Type A	(0)4 - 20mA. Analog input signal can be scaled to any desired range within 0 - 20mA.
Type U	0 - 10V DC. Contact factory.
Accuracy	Resolution: 14 bit. Error < 0.025mA / ± 0.125% FS. Low level cut-off programmable.
Span	0.000010 - 9,999,999 with variable decimal position.
Update time	Four times per second.
Voltage drop	Type A: 2.5V @ 20mA.
Relationship	Linear and square root calculation.
Note A	For signal type A: external power to sensor is required; e.g. type PD.

Signal inputs - Additional input

Function	<ul style="list-style-type: none"> Terminal input to reset total remotely. If this terminal input is closed, the "clear total"-function is disabled.
Type IB	Internally pulled-up switch contact - NPN.
Duration	Minimum pulse duration 100msec.

Signal outputs - Digital output

Function	Pulse output - transmitting accumulated total.
Frequency	Max. 500Hz. Pulse width user definable between 0.001 second up to 9.999 seconds.
Type OA	One active 24V DC transistor output (PNP); max. 50mA per output (requires -PD, PF, PM or PX). Requires min. 24V power supply
Type OR	One electro-mechanical relay output - isolated; max. switch power 230V AC (N.O.) - 0.5A per relay (requires PF or PM).
Type OT	One passive transistor output (NPN) - not isolated. Max. 50V DC - 300mA per output.

Signal outputs - Analog output

Function	Transmitting flow rate.
Accuracy	10 bit. Error < 0.05%. Analog output signal can be scaled to any desired range.
Update time	Eight times per second.
Type AA	Active 4 - 20mA output (requires PD, PF, PM or PX).
Type AB	Active 0 - 20mA output (requires PD, PF, PM or PX).
Type AF	Passive floating 4 - 20mA output for Intrinsically Safe applications (requires XI + PD).
Type AI	Passive galvanically isolated 4 - 20mA output - also available for battery powered models.
Type AP	Passive 4 - 20mA output - not isolated. Unit will be loop powered.
Type AU	Active 0 - 10V DC output (requires PD, PF, PM or PX). Requires min. 12V power supply.

Signal outputs - Communication option

Function	Reading display information, reading / writing all configuration settings.
Protocol	Modbus ASCII / RTU.
Speed	1200 - 2400 - 4800 - 9600 baud.
Addressing	Maximum 255 addresses.
Type CB	RS232
Type CH	RS485 2-wire
Type CI	RS485 4-wire
Type CT	TTL Intrinsically Safe.

Power requirements

Type AP	Analog output loop powered, 8 - 30V DC. Power consumption max 0.5 Watt.
Type PB	Long life Lithium battery - life-time depends upon settings and configuration - up to 5 years. (requires PD, PL or PX)
Type PC	Intrinsically Safe long life lithium battery life-time depends upon settings and configuration - up to 5 years. (requires XI and PD, PL or PX)
Type PD	8 - 24V AC / DC \pm 10%. Power consumption max. 5W. Intrinsically Safe: 16 - 30V DC; power consumption max. 1 W.
Type PF	24V AC / DC \pm 10%. Power consumption max. 15W.
Type PL	Input loop powered from sensor signal 4 - 20mA (type "A") - requires types AI and OT (not XI).
Type PM	115 - 230V AC \pm 10%. Power consumption max. 15W.
Type PX	8 - 30V DC. Power consumption max. 0.75W.
Type ZB	12 - 30V DC \pm 10%. Power consumption max. 1.5W.
Note PB/PF/PM	Not available Intrinsically Safe.
Note PF/PM	The total consumption of the sensors and outputs may not exceed 400mA @ 24V.
Note XI	For Intrinsically Safe applications, consult the safety values in the certificate.

Sensor excitation

Type PB/PC/PX	3V DC for pulse signals and 1.2V DC for coil pick-up.
Note PB/PC/PX	This is not a real sensor supply. Only suitable for sensors with a very low power consumption like coils (sine wave) and reed-switches.
Type PD	1.2 / 3 / 8.2 / 12 / 24V DC - max. 50mA @ 24V DC. U_{max} sensor is 2V below U_{supply}
Type PD-XI	1.2 / 3 / 8.2V DC - max. 7mA @ 8.2V DC and mains power supply voltage (as connected to terminal 1).
Note PD-XI	In case PD-XI and signal A: the sensor supply voltage is according to the power supply voltage connected to terminal 1. Also terminal 2 offers the same voltage.
Type PF / PM	1.2 / 3 / 8.2 / 12 / 24V DC - max. 400mA @ 24V DC.

Operator functions

Displayed info	<ul style="list-style-type: none"> Flow rate and / or total Total and accumulated total. Total can be reset to zero by pressing the CLEAR-key twice.
-----------------------	---

Total

Digits	7 digits.
Units	L, m ³ , GAL, USGAL, kg, lb, bbl, no unit.
Decimals	0 - 1 - 2 or 3.
Note	Total can be reset to zero.

Accumulated total

Digits	11 digits.
Units / decimals	According to selection for total.
Note	Can not be reset to zero.

Flow rate

Digits	7 digits.
Units	mL, L, m ³ , Gallons, kg, Ton, lb, bl, cf, RND, ft ³ , scf, Nm ³ , NI, igal - no units.
Decimals	0 - 1 - 2 or 3.
Time units	/sec - /min - /hr - /day.

Mounting accessories

ACF02	Stainless steel wall mounting kit.
ACF05	Stainless steel pipe mounting kit (worm gear clamps not included).
ACF06	Two stainless steel worm gear clamps \varnothing 44 - 56mm.
ACF07	Two stainless steel worm gear clamps \varnothing 58 - 75mm.
ACF08	Two stainless steel worm gear clamps \varnothing 77 - 95mm.
ACF09	Two stainless steel worm gear clamps \varnothing 106 - 138mm.
ACF11	Swivel with 25° movement from center axis for direct flowmeter mounting: 1" NPT to 1/2" NPT.

Intrinsically Safe isolators

ACG01	MTL5511 - One channel pulse or switch output transfer from hazardous area to safe area.
ACG02	MTL5525 - One channel power supply from safe area to hazardous area (e.g. to power the unit with PD or to power a switching or analog device in hazardous area).
ACG03	MTL5541 - One channel 4 - 20mA repeater from hazardous area to safe area.
ACG04	MTL 5051 - Bi-direction serial-data-isolator (for Modbus communication).
ACG05	MTL5516C - Two channel pulse or switch output transfer from hazardous area to safe area.
ACG06	MTL5513 - One channel pulse or switch output transfer from hazardous area to safe area.
ACG07	MTL5546Y - One channel isolated driver bringing 4 - 20mA from safe area to hazardous area, HART transparent, OCD.

		Description	
Model	F110	Flow rate indicator / totalizer with analog and pulse signal outputs.	
Input	A	(0)4 - 20mA input.	-A
	P	Pulse input, e.g., coil, npn, pnp, namur, reed-switch.	-P
Analog output	AA	Active 4 - 20mA output - requires XX and PD, PF, PM or PX.	-AA
	AB	Active 0 - 20mA output - requires XX and PD, PF, PM or PX.	-AB
	AF	I.S. floating 4 - 20mA output - requires XI + PC or PD.	-AF
	AI	Isolated 4 - 20 mA output - requires XX.	-AI
	AP	Passive 4 - 20mA output, loop powered unit.	-AP
	AU	Active 0 - 10V DC output - requires XX and PD, PF, PM or PX.	-AU
Communication	CB	Communication RS 232 - Modbus ASCII / RTU - requires XX.	-CB
	CH	Communication RS 485 - 2wire - Modbus ASCII / RTU - requires XX.	-CH
	CI	Communication RS 485 - 4wire - Modbus ASCII / RTU - requires XX.	-CI
	CT	Intrinsically Safe TTL - Modbus ASCII / RTU - requires XI.	-CT
	CX	No communication.	-CX
Enclosures	HB	Aluminum panel mount enclosure.	-HB
	HC	GRP panel mount enclosure.	-HC
	HD	GRP field mount - Cable entry: no holes.	-HD
	HE	GRP field mount - Cable entry: 2 x Ø 16mm & 1 x Ø 20mm.	-HE
	HF	GRP field mount - Cable entry: 1 x Ø 22mm ($\frac{7}{8}$ ").	-HF
	HG	GRP field mount - Cable entry: 2 x Ø 20mm.	-HG
	HH	GRP field mount - Cable entry: 6 x Ø 12mm.	-HH
	HJ	GRP field mount - Cable entry: 3 x Ø 22mm ($\frac{7}{8}$ ").	-HJ
	HK	GRP field mount - Flat bottom, cable entry: no holes.	-HK
	HA	Aluminum field mount - Cable entry: 2 x PG9 + 1 x M20.	-HA
	HL	Aluminum field mount - Cable entry: 2 x $\frac{1}{2}$ "NPT.	-HL
	HM	Aluminum field mount - Cable entry: 2 x M16 + 1 x M20.	-HM
	HN	Aluminum field mount - Cable entry: 1 x M20.	-HN
	HO	Aluminum field mount - Cable entry: 2 x M20.	-HO
	HP	Aluminum field mount - Cable entry: 6 x M12.	-HP
	HT	Aluminum field mount - Cable entry: 1 x $\frac{1}{2}$ "NPT.	-HT
	HU	Aluminum field mount - Cable entry: 3 x $\frac{1}{2}$ "NPT.	-HU
	HV	Aluminum field mount - Cable entry: 4 x M20.	-HV
	HZ	Aluminum field mount - Cable entry: no holes.	-HZ
	HBM	Extended Alu. field/meter mount - Cable entry: 2 x M16 + 1 x M20.	-HBM
	HBO	Extended Alu. field/meter mount - Cable entry: 2 x M20.	-HBO
	HBU	Extended Alu. field/meter mount - Cable entry: 3 x $\frac{1}{2}$ "NPT.	-HBU
	HSM	Stainless steel 316L field mount - Cable entry: 2 x M16 + 1 x M20.	-HSM
	HSO	Stainless steel 316L field mount - Cable entry: 2 x M20.	-HSO
	HSU	Stainless steel 316L field mount - Cable entry: 3 x $\frac{1}{2}$ "NPT.	-HSU
	Additional	IB	Remote control input to reset total or to lock the "clear total" button.
IX		No remote control input.	-IX
Digital output	OA	One active transistor output - requires XX and PD, PF, PM or PX.	-OA
	OR	One mechanical relay output - requires XX and PF or PM.	-OR
	OT	One passive transistor output.	-OT
Power	PD	8 - 24V AC/DC + sensor supply - with XI: 16 - 30V DC.	-PD
	PF	24V AC/DC + sensor supply - requires XX.	-PF
	PL	Input loop powered from sensor signal type "A" - requires XX, AI and OT.	-PL
	PM	115 - 230V AC + sensor supply - requires XX.	-PM
	PX	Basic power supply 8 - 30V DC.	-PX
Battery	PB	Additional lithium battery powered (optional) - requires XX and PD or PX.	-PB -P_
	PC	Additional lithium battery powered (optional) - Intrinsically safe - requires XI, and PD or PX.	-PC -P_
Hazardous	XI	Intrinsically safe, according ATEX and IECEx.	-XI
	XF	Ex d enclosure - 3 keys according ATEX.	-XF
	XX	Safe area only.	-XX
Options	ZB	Backlight - requires XX.	-ZB
	ZF	Coil input 10mVpp.	-ZF
	ZX	No options.	-ZX

The **bold** marked text contains the standard configuration: F110-P-AP-CX-HC-IX-OT-PX-XX-ZX.

